

# 女子個人試合

## 48kg級

第三試合場

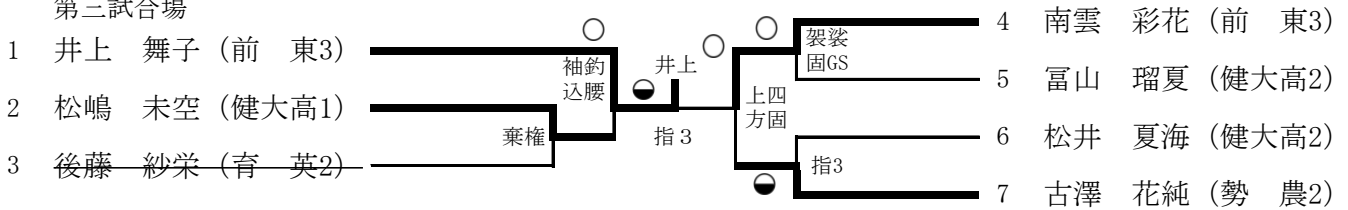

補欠決定戦

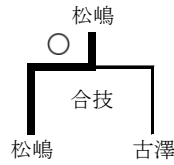

## 52kg級

第二試合場

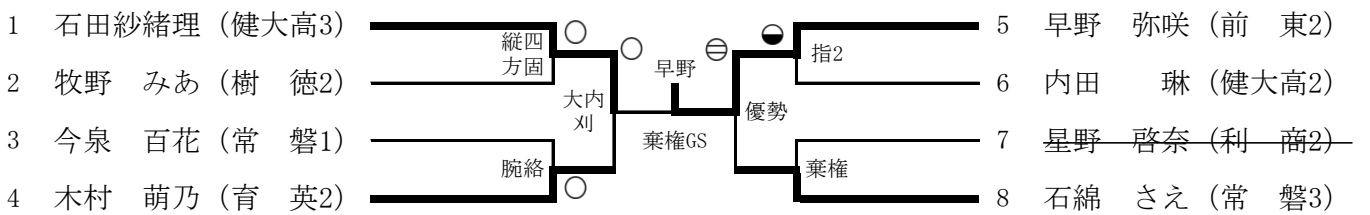

補欠決定戦

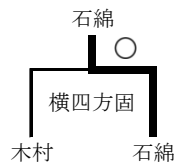

## 57kg級

第三試合場

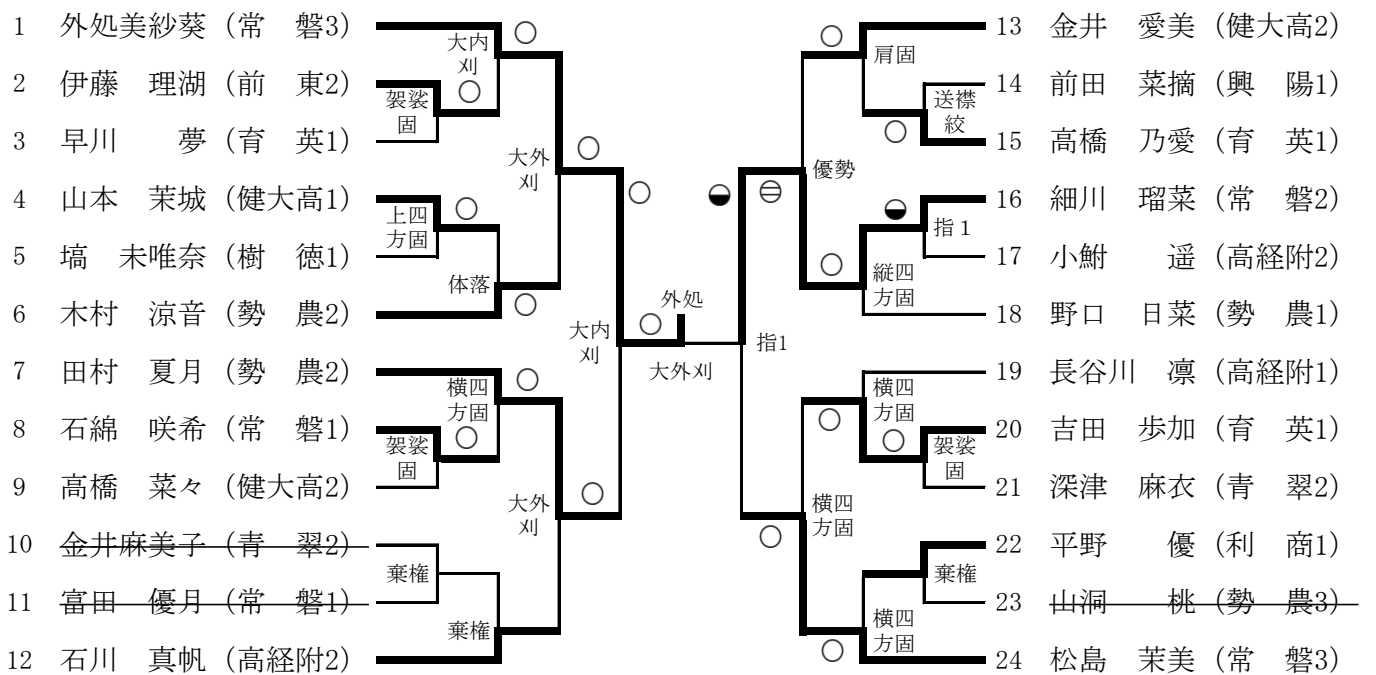

補欠決定戦

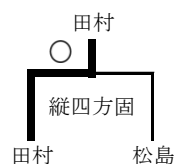

### 63kg級

第三試合場

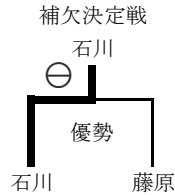
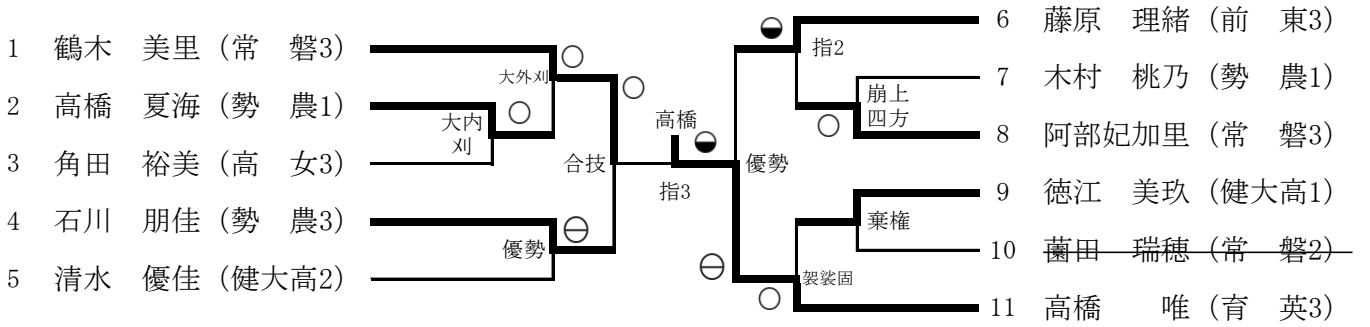

### 70kg級

第一試合場

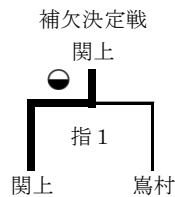
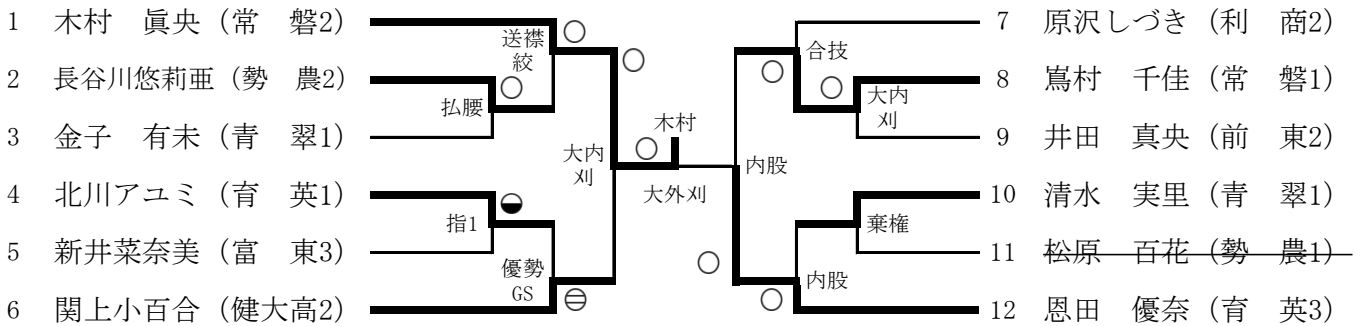

### 78kg級

第二試合場

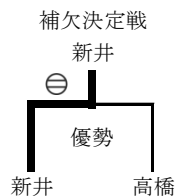
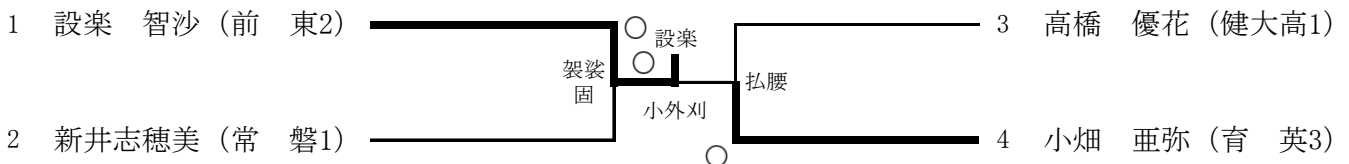

### 78kg超級

